

Weather Station with Lightning Detector

models 01022, 02080, 06046



CONTENTS

Unpacking Instructions	2	5-in-1 Sensor Installation.....	15
Package Contents	2	Using the Weather Center	16
Product Registration	2	Rainfall Tracking	18
Features & Benefits: Lightning Sensor ..	3	Weather Ticker	19
Features & Benefits: 5-in-1	4	Programmable Alarms.....	20
Features & Benefits: Display.....	5	Troubleshooting	22
Setup	9	Care & Maintenance.....	24
Lightning Sensor Setup	9	Calibration	24
5-in-1 Sensor Setup	10	Specifications.....	26
Display Setup	11	FCC Information	26
Set the Time, Date & Units	12	Customer Support	27
Backlight Settings.....	12	Warranty.....	27
Placement Guidelines	13		

Questions? Contact Customer Support at
(877) 221-1252 or visit www.AcuRite.com.

SAVE THIS MANUAL FOR FUTURE REFERENCE.

ACURITE®

Congratulations on your new AcuRite product. To ensure the best possible product performance, please read this manual in its entirety and retain it for future reference.

Unpacking Instructions

Remove the protective film that is applied to the LCD screen prior to using this product. Locate the tab and peel off to remove.

Package Contents

1. Display with Tabletop Stand
2. 5-in-1 Sensor
3. Lightning Sensor
4. Sensor Mounting Bracket
5. Mounting Hardware
6. Power Adapter
7. Instruction Manual

IMPORTANT

PRODUCT MUST BE REGISTERED
TO RECEIVE WARRANTY SERVICE

PRODUCT REGISTRATION

Register online to receive 1 year warranty protection

www.AcuRite.com

Features & Benefits

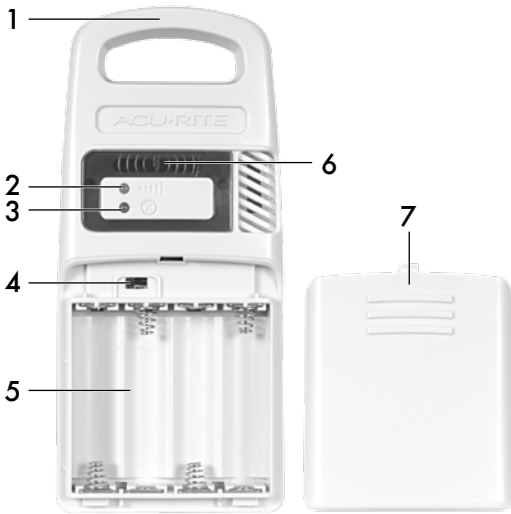

LIGHTNING SENSOR

- 1. Integrated Hanger**
For easy placement.
- 2. Wireless Signal Indicator**
Flashes when data is being sent to the companion unit.
- 3. Interference Indicator**
Flashes when interference is detected (see page 14).
- 4. A-B-C Switch**
ID code that must match display's A-B-C switch to ensure units synchronize.
- 5. Battery Compartment**
- 6. Lightning Strike Indicator**
Indicates a lightning strike has occurred within 25 miles (40 km).
- 7. Battery Compartment Cover**

NOTE: Under no circumstances shall the Lightning Detector, Chaney Instrument Co. or the Primex Family of Companies be held responsible for any damages whatsoever that may result from the use of or inability to use this product, including without limitation any indirect, incidental, special, exemplary or consequential damages, which are expressly disclaimed. This disclaimer of liability applies to any damages or injury caused by any failure of performance, error, omission, inaccuracy, interruption, deletion, defect, delay in operation or transmission software virus, communication failure, theft or destruction or unauthorized access to, alteration of, or use of the product, whether for breach of contract, tortious behavior (including, without limitation, strict liability), negligence, or under any other cause of action, to the fullest extent permissible by law. This does not affect any statutory rights which may not be disclaimed. The contents of this product, including all lightning and weather data are provided "as is" and without warranty or condition of any kind, express or implied, including, without limitation, any warranty of merchantability or fitness for a particular purpose. Chaney Instrument Co. & the Primex Family of Companies do not warrant that this product or the data that it provides will be free of errors, interruptions, viruses or other harmful components. Chaney Instrument Co. & the Primex Family of Companies do not warrant the accuracy or reliability of any lightning strike alerts, weather data or other information provided by the product. Chaney Instrument Co. & the Primex Family of Companies reserve the right to alter the product or withdraw it from the market at its sole discretion.

Features & Benefits

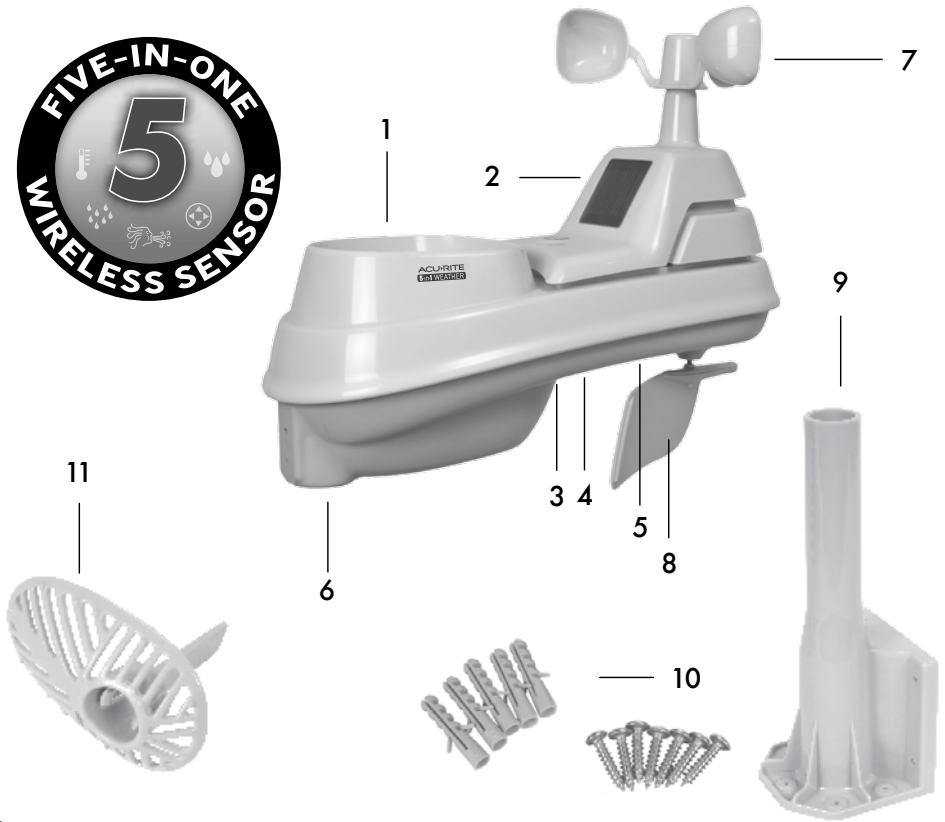

5-in-1 SENSOR

- 1. Rainfall Collector Funnel**
- 2. Solar Cell Panel**
Converts sunlight into power to run internal aspirating fan.
- Internal Aspirating Fan**
(not shown)
Draws ambient air into sensor to reduce solar radiation heating, resulting in more accurate temperature measurement.
- 3. A-B-C Switch**
ID code that must match display's A-B-C switch to ensure units synchronize.
- 4. Battery Compartment**

- 5. Temperature & Humidity Sensors**
(internal)
- 6. Mounting Point**
- 7. Wind Speed Anemometer**
- 8. Wind Direction Vane**
- 9. Mounting Bracket**
- 10. Mounting Hardware**
Includes 5 anchors & the following screws:

Qty	Diameter	Length
5	#4	3/4"
1	#4	1/2"
1	#6	1/2"

- 11. Debris Filter**
Pre-installed to prevent debris from entering the rain gauge.

Features & Benefits



FRONT OF DISPLAY

- 1. > Button**
Press to view rainfall records (see page 18).
- 2. select Button**
Press to cycle through available readings and access options, alarms and records menu.
- 3. ^ and v Buttons**
For setup preferences and manually cycling through Weather Ticker messages (when display is not connected to additional sensors). For manually cycling add-on sensor data (when display is connected to additional sensors).
- 4. options Button**
For calibration and setup preferences.
- 5. SET enter Button**
For setup preferences.
- 6. alarms Button**
For alarm setup preferences.
- 7. records Button**
Press to view historical records for reading selected.
- 8. clear Button**
Press to clear selected record.

Features & Benefits

FRONT OF DISPLAY



- 1. Current Outdoor Temperature**
Arrow indicates direction temperature is trending.
- 2. Outdoor Low Temperature Record**
Lowest temperature recorded since midnight.
- 3. Outdoor High Temperature Record**
Highest temperature recorded since midnight.
- 4. Current Outdoor Humidity**
Arrow indicates direction humidity is trending.
- 5. Outdoor Low Humidity Record**
Lowest humidity recorded since midnight.
- 6. Outdoor High Humidity Record**
Highest humidity recorded since midnight.
- 7. Weather Select**
Heat Index calculation displays when temperature is 80°F (27°C) or higher. Dew Point calculation displays when temperature is 79°F (26°C) or below. Wind chill calculation displays when temperature is 40°F (4°C) or lower.
- 8. Alarm ON Indicator**
Indicates alarm is activated to emit an audible alert when conditions exceed your presets (see page 20).
- 9. Rainfall**
Displays most recent rainfall total (today, yesterday or this week).
- 10. Rainfall History**
Displays historical rainfall totals (see page 18).
- 11. 5-in-1 Sensor Signal Strength**
- 12. 5-in-1 Sensor Low Battery Indicator**
- 13. Lightning Sensor Signal Strength**
- 14. Interference Indicator**
Flashes when interference is detected (see page 14).
- 15. Lightning Sensor Low Battery Indicator**
- 16. Weather Ticker**
Streams real-time data (see page 19).
- 17. Strike Counter**
Displays most recent total of lightning strikes that has been detected (today, this week, this month).
- 18. Clock**
Automatically updates for Daylight Saving Time.
- 19. Lightning Strike Indicator**
Indicates a lightning strike has occurred within 25 miles.
- 20. Estimated Distance to Storm Front**
Updates with latest lightning strike detected today.
- 21.  Icon**
Indicates display is in auto-dimming brightness mode (see page 12).
- 22. Display Low Battery Indicator**
- 23. Date**
- 24. Add-on Sensor Low Battery Indicator**
If applicable (see page 17).
- 25. Add-On Sensor Signal Strength**
If applicable (see page 17).
- 26. Auto-Cycle Indicator**
Indicates auto-cycle mode is enabled. If applicable (see page 17).
- 27. Add-On Sensor Indicator**
If applicable (see page 17).
- 28. Current Humidity for #27 or #30**
Arrow icon indicates direction humidity is trending.
- 29. Humidity Level Indicator**
Indicates a high, low, or ideal humidity comfort level.
- 30. Indoor Indicator**
Indicates indoor (display) conditions are being shown.
- 31. Current Temperature for #27 or #30**
Arrow icon indicates direction temperature is trending.
- 32. Peak Wind Speed**
Highest speed from the last 60 minutes.
- 33. Average Wind Speed**
Average wind speed over the past 2 minutes.
- 34. Current Wind Direction**
- 35. Current Wind Speed**
- 36. Wind Speed Alert Indicator**
Activates when wind speed is over 32 mph.
- 37. Learning Mode Icon**
Disappears after weather forecast self-calibration is complete (see page 16).
- 38. Previous 2 Wind Directions**
- 39. 12 to 24 Hour Weather Forecast**
Self-Calibrating Forecasting pulls data from your 5-in-1 sensor to generate your personal forecast.
- 40. Barometric Pressure**
Arrow icon indicates direction pressure is trending.
- 41. Freeze Alert Indicator**
Indicates temperature is below freezing (32°F; 0°C).

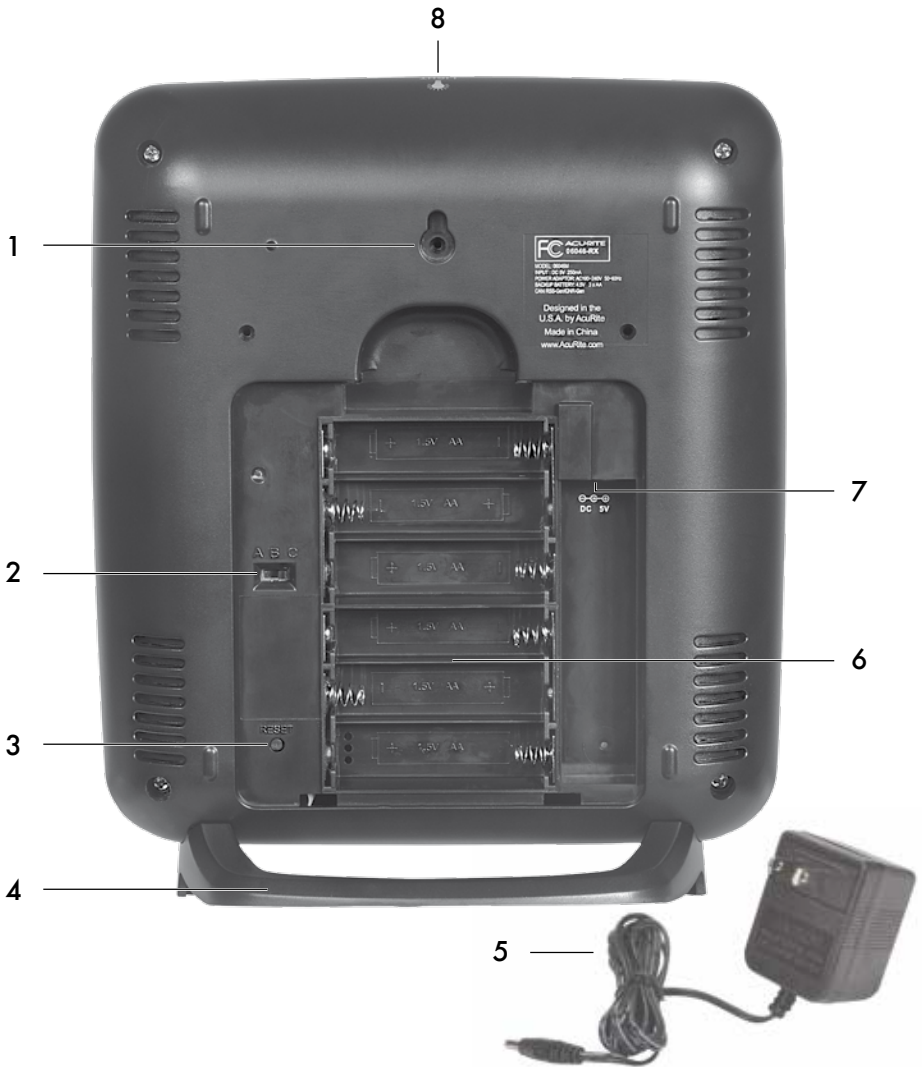

BACK OF DISPLAY

- 1. Integrated Hang Hole**
For easy wall mounting.
- 2. A-B-C Switch**
ID code that must match the 5-in-1 sensor and lightning sensor's A-B-C switches to ensure units synchronize.
- 3. RESET Button**
Press and release for full reset to factory defaults.
- 4. Removable Tabletop Stand**
- 5. Power Adapter**
- 6. Battery Compartment Cover**
(not shown)
- 7. Plug-in for Power Adapter**
- 8. LIGHT Button**
Dimmer control while using power adapter. Activates momentary backlight while on battery power.

Lightning Sensor Setup

1 Set the A-B-C Switch

Locate the A-B-C switch inside the battery compartment. It can be set to A, B or C. However, you must select the same letter choices for the display, 5-in-1 sensor and lightning sensor in order for the units to synchronize.

2 Install or Replace Batteries

AcuRite recommends high quality alkaline or lithium batteries in the wireless sensor for the best product performance. Heavy duty or rechargeable batteries are not recommended.

The sensor requires lithium batteries in low temperature conditions. Cold temperatures can cause alkaline batteries to function improperly. Use lithium batteries in the sensor for temperatures below -4°F / -20°C.

1. Slide off the battery compartment cover.
2. Insert 4 x AA batteries into the battery compartment, as shown. Follow the polarity (+/-) diagram in the battery compartment.
3. Replace the battery cover.

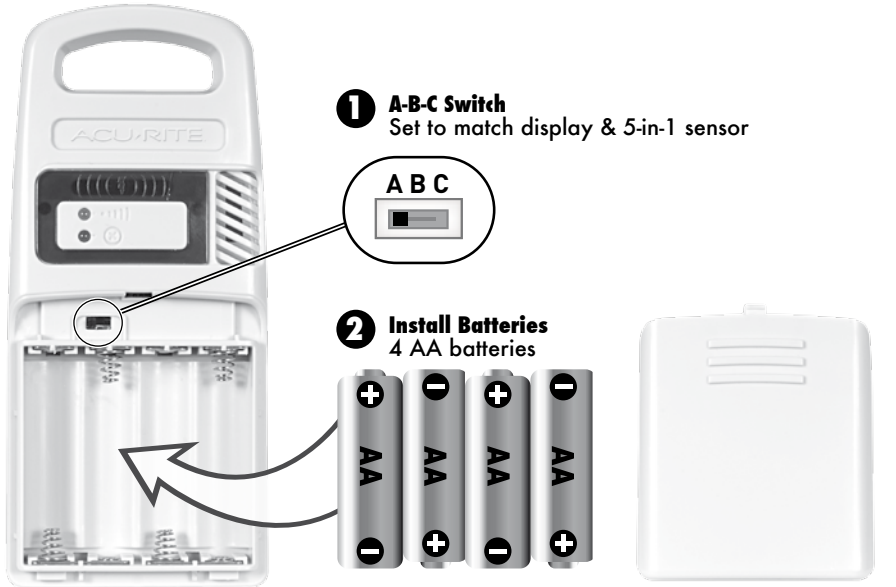

LITHIUM BATTERIES **-40°F** (-40°C) (70°C) **158°F**

ALKALINE BATTERIES **-4°F** (-20°C) (70°C) **158°F**



PLEASE DISPOSE OF OLD OR DEFECTIVE BATTERIES IN AN ENVIRONMENTALLY SAFE WAY AND IN ACCORDANCE WITH YOUR LOCAL LAWS AND REGULATIONS.

BATTERY SAFETY: Clean the battery contacts and also those of the device prior to battery installation. Remove batteries from equipment that will not be used for an extended period of time. Follow the polarity (+/-) diagram in the battery compartment. Promptly remove dead batteries from the device. Dispose of used batteries properly. Only batteries of the same or equivalent type as recommended are to be used. DO NOT incinerate used batteries. DO NOT dispose of batteries in fire, as batteries may explode or leak. DO NOT mix old and new batteries or types of batteries (alkaline/standard). DO NOT use rechargeable batteries. DO NOT recharge non-rechargeable batteries. DO NOT short-circuit the supply terminals.

5-in-1 Sensor Setup

1 Set the A-B-C Switch

Locate the A-B-C switch inside the battery compartment. It can be set to A, B or C. However, you must select the same letter choices for the display, 5-in-1 sensor and lightning sensor in order for the units to synchronize.

2 Install or Replace Batteries

Batteries **MUST** be installed for this product to operate. AcuRite recommends high quality alkaline or lithium batteries for the best product performance. Heavy duty or rechargeable batteries are not recommended.

The 5-in-1 sensor requires lithium batteries in low temperature conditions. Cold temperatures can

cause alkaline batteries to function improperly. Use lithium batteries in the 5-in-1 sensor for temperatures below -4°F/-20°C.

1. Slide off the battery compartment cover.
2. Insert 4 x AA batteries into the battery compartment, as shown. Follow the polarity (+/-) diagram in the battery compartment.
3. Replace the battery cover.

3 Remove Rain Gauge Stabilizer

Locate and remove the rain gauge stabilizer (plastic tab) taped into the bottom of the sensor. The rain gauge will not function until this is removed.

LITHIUM BATTERIES -40°F (-40°C) (70°C) 158°F

ALKALINE BATTERIES -4°F (-20°C) (70°C) 158°F

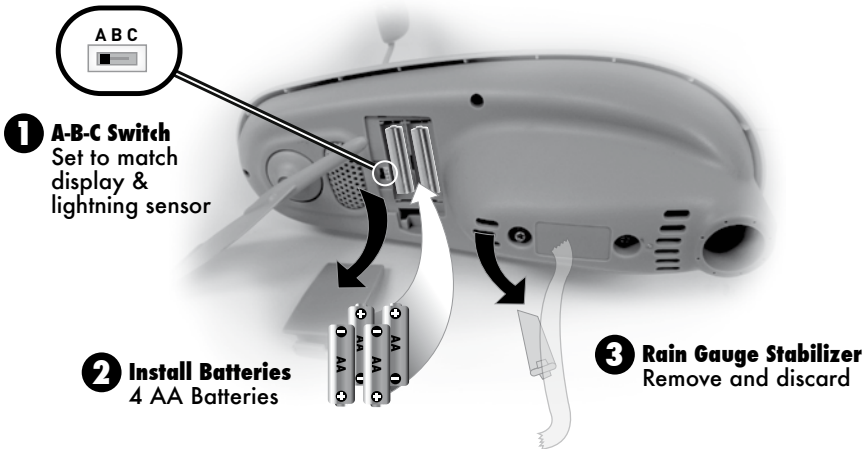

NOTE: If add-on sensors are being used with the display (see page 17), set them up at this time. If pairing more than one wireless sensor with the display, the A-B-C channel must differ between each add-on sensor. The display will automatically begin searching for add-on sensors during initial setup.

Display Setup

AcuRite recommends high quality alkaline batteries for the best product performance. Heavy duty or rechargeable batteries are not recommended.

1 Set the A-B-C Switch

Locate the A-B-C switch inside the battery compartment. It can be set to A, B or C. However, you must select the same letter choices for the display, 5-in-1 sensor and lightning sensor in order for the units to synchronize.

2 Plug Power Adapter into Electrical Outlet

3 Install or Replace Backup Batteries (optional)

Insert 6 x AA alkaline batteries into the battery compartment, as shown. Follow the polarity (+/-) diagram in the battery compartment.

1 A-B-C Switch Set to match 5-in-1 sensor and lightning sensor

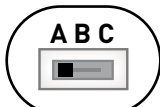

3 Install Backup Batteries (optional) 6 AA Batteries

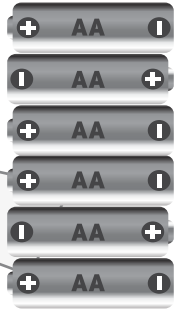

2 Plug in Power Adapter



IMPORTANT: Batteries are a backup power source to preserve records in the event of a power outage. Power adapter is the recommended primary power source to enjoy the full functionality of this product.

Set the Time, Date & Units

The display will automatically enter SET MODE after the unit has powered on. Once in set mode, the preference you are currently setting will blink on the display.

To adjust the currently selected (flashing) item, press and release the “^” or “v” buttons (press and HOLD to fast adjust).

To save your adjustments, press and release the “^{SET}enter” button again to adjust the next preference. The preference set order is as follows:

LANGUAGE (English, French)
COUNTRY (USA, Canada, Australia, Other)
TIME ZONE (EST, CST, MST, PST, AKT, HAT, NST, AST)
AUTO DST CHANGE* (YES, NO)
WEATHER TICKER SPEED (SLOW, MEDIUM, FAST)
CLOCK HOUR
CLOCK MINUTE
CALENDAR MONTH
CALENDAR DATE
CALENDAR YEAR
TEMPERATURE UNITS (°F or °C)
WIND SPEED UNITS (mph, kph, knots)
RAINFALL UNITS (in or mm)
PRESSURE UNITS (inHg or hPa)
DISTANCE UNITS (mi or km)



*If you live in an area that observes Daylight Saving Time, DST should be set to YES, even if it is not currently Daylight Saving Time.

You will automatically exit SET MODE if no buttons are pressed for 15 seconds. Enter SET MODE at any time by pressing the “^{SET}enter” button.

Display Backlight Settings

This weather station’s color display features three different lighting settings: High (100%) brightness, Medium (60%) brightness and Low (15%) brightness.

Using battery power alone, the backlight is available momentarily for 10 seconds by pressing the “” button.

When the display is powered with the power adapter, the backlight remains on at 100% brightness. Press the “” button once to dim to 60% brightness; press again to dim to 15%, press a 3rd time to enter “AUTO DIM” mode. “” will appear next to the clock.

NOTE: Pressing and holding the “” button for 5 seconds will disable the backlight. Once any button is pressed, the backlight will return to your selected setting.

AUTO DIM MODE: Automatically adjusts display brightness based on time of day.

6:00 a.m. - 9:00 p.m. = 100% brightness

9:01 p.m. - 5:59 a.m. = 15% brightness

Placement for Maximum Accuracy

AcuRite sensors are sensitive to surrounding environmental conditions. Proper placement of the display, 5-in-1 sensor and lightning sensor is critical to the accuracy and performance of this product.



Display Placement

Place the display in a dry area free of dirt and dust. To ensure accurate temperature measurement, place out of direct sunlight and away from heat sources or vents. Display stands upright for tabletop use or is wall-mountable.



5-in-1 Sensor Placement

The 5-in-1 sensor is designed to remain outdoors all year long. Choose an open location with no obstructions above or around the sensor for the most accurate measurements.



Lightning Sensor Placement

The Lightning Sensor is water-resistant and is designed for general outdoor use, however, to extend its life place the sensor in an area protected from direct weather elements.

Hang the sensor using the integrated hanger, or by using string (not included) to hang it from a suitable location, like a well covered tree branch. The best location is 4 to 8 feet above the ground with permanent shade and plenty of fresh air to circulate around the sensor.

Important Placement Guidelines

Display must be within 330 feet (100 meters) of 5-in-1 sensor and lightning sensor.

MAXIMIZE WIRELESS RANGE

Place units away from large metallic items, thick walls, metal surfaces, or other objects that may limit wireless communication.

PREVENT WIRELESS INTERFERENCE

Place units at least 3 feet (.9 m) away from electronic devices (TV, computer, microwave, radio, etc.).

LOCATE AWAY FROM HEAT SOURCES

Position sensor away from heaters, air conditioners, chimneys, exhaust vents, asphalt and concrete (surfaces that radiate heat).

LOCATE AWAY FROM HUMIDITY SOURCES

Avoid installing the sensor near pools, spas, or other bodies of water. Water sources may impact humidity accuracy.

LOCATE AWAY FROM SPRINKLER HEADS

DO NOT install the sensor where it will be sprayed by a sprinkler system. This may force water inside the sensor.

LOCATE AWAY FROM WIND & RAIN OBSTRUCTIONS

DO NOT mount the sensor with obstructions around it. Consider a location that is a wide open area, with few structures around to ensure accurate wind measurement.

Visit us online to view installation photos and video, or learn more about AcuRite technology:

www.AcuRite.com/5in1



View Video

Lightning Sensor Installation Guidelines

False Detection

This sensor features advanced technology to distinguish between lightning strikes and interference, however in rare cases the sensor may "false detect" lightning activity due to interference. In these situations, verify there is no lightning in the area and then relocate the sensor. If the false detections persist, identify and relocate the source of interference or relocate the sensor.

Interference

The sensor features enhanced interference rejection capabilities to prevent false lightning detection. When the detector cannot detect lightning due to interference from nearby equipment, the sensor's interference indicator will flash.

- Electric motors (windshield wiper motor or fan motors in cars, hard drive and optical drive motors on your PC and AV equipment, well pumps, sump pumps)
- CRT monitors (PC monitors, TV's)
- Fluorescent light fixtures (turned off or on)
- Microwave ovens (while in use)
- PC's and mobile phones

WARNING: Take shelter IMMEDIATELY when lightning is present, whether or not it has been detected by the Lightning Detector. If you are concerned about lightning strikes, follow all safety precautions to keep yourself and others safe. DO NOT rely on this Lightning Detector as your only source for warnings about potentially deadly lightning strikes or other severe weather conditions.

5-in-1 Sensor Installation Guidelines

INSTALLATION HEIGHT Mount the sensor at a minimum height of 5 feet (1.5 meters) off the ground, in an open area. Higher is better for wind measurements - the National Weather Service recommends 33 feet (10 meters) high!

MOUNTING OPTIONS The included mounting bracket is designed to screw directly onto wooden posts or surfaces that are 2" x 4" or larger. The sensor can also be mounted directly to 3/4" steel pipe (available at hardware stores and home centers).

SOLAR CELL INSTALLATION Install the sensor with the **solar cell facing SOUTH**. This ensures the cell receives as much sun as possible and orients wind direction.

5-in-1 Sensor Installation

1. Fasten mounting base (included) to a post or pole (not included) using the 4 longer screws included in the hardware bag.
2. Insert the mounting base into the hole on the bottom of the sensor.
3. Make sure the arrows on the top of the sensor are pointed in the proper direction and the bubble level is centered. The solar cell should be facing south to properly orient the wind direction.
4. Fasten the sensor into the mounting base using the 2 shorter screws included in the hardware bag.

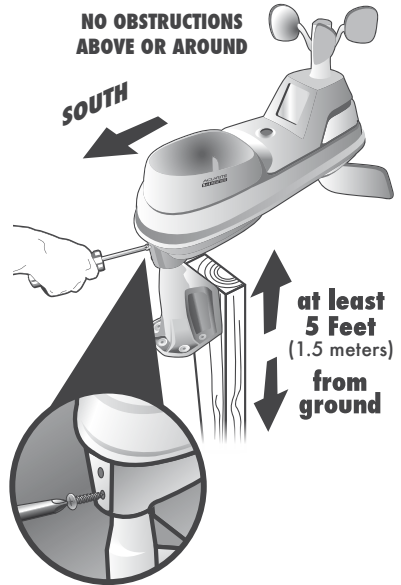

The 5-in-1 sensor is now ready to use.

Basic Setup is Complete

The 5-in-1 sensor will now synchronize with the display. It may take a few minutes for synchronization to complete. If both or one of the units appear to be functioning improperly, please refer to the troubleshooting section.





Using the Professional Weather Center

Learning Mode

Self-Calibrating Forecasting use a unique algorithm to analyze changes in pressure over a time period (called Learning Mode) to determine your altitude. After 14 days, the ☉ icon disappears from the display screen. At this point, the self-calibrated pressure is tuned in to your location and the unit is ready for superior weather prediction.

Weather Forecast

AcuRite's patented Self-Calibrating Forecasting provides your personal forecast of weather conditions for the next 12 to 24 hours by collecting data from the sensor in your backyard. It generates a forecast with pinpoint accuracy - personalized for your exact location.

<p>STORMY & WINDY</p>  <p>(flashing=stormy)</p>	<p>SNOW LIKELY</p> 	<p>SNOW / RAIN MIX LIKELY</p> 	<p>RAIN LIKELY</p> 	<p>CLOUDY</p> 
---	---	--	---	--

View the complete list of icons at www.AcuRite.com/acurite-icons

Weather Select

Weather Select displays data including wind chill, dew point and heat index based on current outdoor conditions. To manually change the Weather Select reading being displayed:

1. Press and release the "select" button until "WEATHER SELECT" is shown on the Weather Ticker.
2. Press and release the "options" button.
3. Press and release the "∧" or "∨" buttons until the desired reading is shown on the display.
4. Press and release the "SET enter" button to save your selection.

After 5 seconds of inactivity, you will exit set mode.

Wind Speed

This weather center displays the current, average and peak wind speeds. By default, average wind speed is calculated in 2-minute intervals. To adjust the time interval for average wind speed calculations:

1. Press and release the "select" button until "WIND SPEED AVERAGE" is shown on the Weather Ticker.
2. Press and release the "options" button.
3. Press and release the "SET enter" button.
4. Press and release the "∧" or "∨" buttons until the desired interval is shown on the display.
5. Press and release the "SET enter" button to save your selection.

After 5 seconds of inactivity, you will exit set mode.

Barometric Pressure

Subtle variations in barometric pressure greatly affect the weather. This weather center displays the current pressure with an arrow icon to indicate the direction the pressure is trending (FALLING, STEADY, or RISING).



Lightning Detection

The lightning sensor detects cloud-to-cloud, cloud-to-ground and intra-cloud lightning. When lightning is detected, the sensor will beep and the strike indicator will flash for each of the first 10 strikes. After 10 strikes, the sensor will enter silent mode but will continue to flash. The sensor will stay in silent mode for 2 hours after the last lightning detection.

The display will automatically show the most recent lightning event (TODAY, WEEK, MONTH). The (⚡) icon appears on the display when lightning is detected and keeps a running count of lightning strikes detected. The display shows an estimate of the distance to the front of today's lightning-producing storm.

Expand the System

The display features built-in sensors for measuring temperature and humidity at its location. The display can be expanded to track additional areas by using compatible Temperature & Humidity Sensors (optional; sold separately). Add up to 3 indoor/outdoor sensors to observe conditions in additional locations within 330 ft (100 m). Compatible Sensors are available at: www.AcuRite.com

Compatible Sensors	Perfect for:
 <p>Temperature & Humidity Sensor Model 06002</p>	<ul style="list-style-type: none">• Indoor and outdoor applications
 <p>Temperature & Humidity Sensor Model 06044</p>	<ul style="list-style-type: none">• Integrated digital display for conditions at a glance• Measures temperature and humidity• For indoor applications

View Indoor/Add-On Sensor Readings

The weather station displays the current indoor temperature and humidity readings, by default.

If the weather station is being used with additional sensors (see Expand the System), toggle between indoor readings and each sensor's readings by pressing and releasing the "∧" or "∨" buttons.

In auto-cycle mode, the display will automatically cycle through indoor and each sensor's data. Auto-cycle mode can be activated by pressing and releasing the "∧" or "∨" buttons until the "↻" indicator appears.

The Sensor Indicator is used to determine which add-on sensor readings you are viewing. For example, if the Sensor Indicator is displaying "A", the readings are being transmitted from the sensor with the A-B-C switch set to "A".

Rainfall Tracking

This weather station features enhanced tracking of historical rainfall data. Rain accumulation data is displayed for the current day, yesterday, or week (most recent rainfall total). Press the ">" button to review historical rainfall records.

Records are shown in the following order:

- CURRENT YEAR TOTAL (default)
- PREVIOUS MONTHLY TOTALS WITH RAIN (up to 12 months prior)
- CURRENT YEAR TOTAL
- PREVIOUS YEAR TOTAL
- ALL-TIME TOTAL

Rainfall Data



TODAY

Displays rainfall recorded TODAY since 12:00am, if applicable.

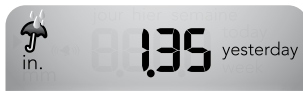

YESTERDAY

If there hasn't been any rainfall this week, the current month's rainfall is displayed.



WEEK

If there hasn't been any rainfall today, the current week's rainfall (Sunday to Saturday) is displayed, if applicable.

Rainfall History



CURRENT YEAR
TOTAL RAINFALL
(default)



TOTAL RAINFALL
FOR MONTH SHOWN



ALL-TIME TOTAL RAINFALL

Weather Ticker™

The Weather Ticker automatically flashes your real-time weather information and alerts as text in the lower part of the display screen.

The possible WEATHER TICKER messages are as follows:

- HEAT INDEX-XX
- WINDCHILL-XX
- DEW POINT-XX

IT FEELS LIKE XX OUTSIDE
TODAY'S HIGH HUMIDITY...OUTDOOR XX/INDOOR XX
TODAY'S LOW HUMIDITY...OUTDOOR XX/INDOOR XX
TODAY'S HIGH TEMP...OUTDOOR XXX/INDOOR XXX
TODAY'S LOW TEMP...OUTDOOR XXX/INDOOR XXX
7 DAY HIGH TEMP. XX-MM/DD
7 DAY LOW TEMP. XX-MM/DD
30 DAY HIGH TEMP. XX-MM/DD
30 DAY LOW TEMP. XX-MM/DD
ALL TIME HIGH TEMP. XXX...RECORDED MM/DD/YY
ALL TIME LOW TEMP. XXX...RECORDED MM/DD/YY
24 HOUR TEMP. CHANGE +XX
ALL TIME HIGH WIND XX MPH...RECORDED MM/DD/YY
7 DAY AVERAGE WIND XX MPH
TODAY'S AVERAGE WIND XX MPH
MOON- NEW
MOON- WAXING CRESCENT
MOON- FIRST QUARTER
MOON-WAXING GIBBOUS
MOON- FULL
MOON- WANING GIBBOUS
MOON- LAST QUARTER
MOON- WANING CRESCENT
INDOOR HUMIDITY OK
INDOOR HUMIDITY HIGH
INDOOR HUMIDITY LOW
NEW LOW TEMP. RECORD XX
NEW HIGH TEMP. RECORD XX
NEW WIND RECORD TODAY XX
CURRENT RAINFALL RATE X.XX /HR.
RAIN EVENT STARTED XX HRS. AGO
5-IN-1 SENSOR BATTERIES LOW
DISPLAY BATTERIES LOW
5-IN-1 SENSOR SIGNAL LOST...CHECK BATTERIES AND PLACEMENT
CAUTION- HEAT INDEX IS XXX
CAUTION- WIND CHILL IS XXX
LIGHTNING DETECTED...XX MILES AWAY...STRIKES CLOSER
LIGHTNING DETECTED...XX MILES AWAY...STRIKES FARTHER AWAY
LIGHTNING STRIKES...LAST 48 HOURS - XXXX
LIGHTNING STRIKES...LAST MONTH - XXXX
LIGHTNING STRIKES...THIS YEAR - XXXX
LIGHTNING STRIKES...LAST YEAR - XXXX
LIGHTNING STRIKES...ALL TIME - XXXX
MOST LIGHTNING...IN ONE DAY - XXXX...MM/DD/YY
CAN'T DETECT LIGHTNING...RELOCATE SENSOR
LIGHTNING SENSOR...BATTERIES LOW
LIGHTNING SENSOR...SIGNAL LOST...CHECK BATTERIES... AND PLACEMENT

High and Low Records

Today's high and low records are displayed for outdoor temperature and humidity. Today's records automatically clear at 12:00am midnight every day.

Historical records (daily, weekly, monthly) can also be viewed by accessing the records menu. Records include:

OUTDOOR TEMPERATURE
OUTDOOR HUMIDITY
BAROMETRIC PRESSURE
WIND SPEED
RAINFALL
INDOOR TEMPERATURE
INDOOR HUMIDITY
LIGHTNING STRIKES

View Records

1. Press and release the "select" button until the reading for which you wish to view is shown on the Weather Ticker screen.
2. Press and release the "records" button to enter RECORDS MODE.
3. Press and release the "∧" or "∨" buttons to cycle through available record values for that reading.
4. Repeat steps 1-3, as needed.

NOTE: To clear a record, press and release the "clear" button while viewing the record you wish to clear. Dashes display to confirm you have cleared the record.

Programmable Weather Alarms

Each selectable weather category features an alarm option. When an alarm sounds, the display emits audible beeping and flashes the affected category, its alarm settings, and any other relevant data.

Alarms can be customized to alert you when your programmed value is reached. Alarms include:

OUTDOOR TEMPERATURE
OUTDOOR HUMIDITY
BAROMETRIC PRESSURE
WIND SPEED
WEATHER SELECT
RAINFALL
INDOOR TEMPERATURE
INDOOR HUMIDITY
LIGHTNING STRIKES (ON/OFF only; ON by default)

Setup an Alarm

Press and release the "select" button until the reading for which you wish to set an alarm for is shown on the Weather Ticker screen.

1. Press and release the "alarms" button to enter ALARM SET MODE.
2. Press and release the "SET_{enter}" button.
3. Press and release the "∧" or "∨" buttons until "ALARM ON" is flashing on the Weather Ticker screen.
4. Press and release the "SET_{enter}" button. The current LOW alarm value will be shown on the display.
5. Press and release the "∧" or "∨" buttons to adjust the alarm's LOW value.
6. Press and release the "SET_{enter}" button. The current HIGH alarm value will be shown on the display.
7. Press and release the "∧" or "∨" buttons to adjust the alarm's HIGH value.
8. Press and release the "SET_{enter}" button.
9. Repeat steps 1-8, as needed.

Disable an Alarm

Press and release the "select" button until the reading for which you wish to set an alarm is shown on the Weather Ticker screen.

1. Press and release the "alarms" button to enter ALARM SET MODE.
2. Press and release the "SET_{enter}" button.
3. Press and release the "∧" or "∨" buttons until "ALARM OFF" is flashing on the Weather Ticker screen.
4. Press and release the "SET_{enter}" button.
5. Repeat steps 1-4, as needed.

NOTE: To disable ALL alarms at once, press and HOLD the "alarms" button for 15 seconds.

Troubleshooting

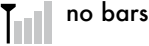
Problem	Possible Solution
<p>No 5-in-1 sensor or lightning sensor reception</p> 	<ul style="list-style-type: none"> • Relocate the display and/or the sensor. The units must be within 330 ft (100 m) of each other. • Make sure all units are placed at least 3 feet (.9 m) away from electronics that may interfere with the wireless communication (such as TVs, microwaves, computers, etc). • Use standard alkaline batteries (or lithium batteries in sensor when temperature is below -20°C/-4°F). Do not use heavy duty or rechargeable batteries. NOTE: It may take a few minutes for display and sensors to synchronize after batteries are replaced. • Synchronize the units: <ol style="list-style-type: none"> 1. Bring both sensors and display indoors and remove power adapter/batteries from all. 2. Reinstall batteries in outdoor sensors. 3. Reinstall power adapter/batteries in display. 4. Let the units sit within a couple feet of each other for a few minutes to gain a strong connection.
<p>Outdoor temperature is flashing or showing dashes</p>	<p>Flashing of the outdoor temperature may be an indication of wireless interference.</p> <ul style="list-style-type: none"> • Make sure the A-B-C switch in the battery compartments the display and both sensors are switched to the same letter. You may choose A, B or C; but units must match to sync up. Sometimes changing to a different channel can help.
<p>Inaccurate forecast</p>	<ul style="list-style-type: none"> • Weather Forecast icon predicts conditions for the next 12 to 24 hours, not current conditions. • Has Learning Mode icon disappeared from the display? Learning Mode must complete before forecast and pressure will be accurate. • Allow unit to run continuously for 33 days. Battery removal or resetting the display will restart Learning Mode. After 14 days, forecast should be fairly accurate, however Learning Mode calibrates for a total of 33 days.
<p>Inaccurate temperature or humidity</p>	<ul style="list-style-type: none"> • Make sure both the display and 5-in-1 sensor are placed away from any heat sources or vents (see page 13). • Make sure both units are positioned away from moisture sources (see page 13). • Make sure 5-in-1 sensor is mounted at least 1.5 m (5 ft) off of the ground. • Calibrate indoor and outdoor temperature and humidity (see page 24).

Troubleshooting

Problem	Possible Solution
No rainfall	<ul style="list-style-type: none"> • Check to ensure the rain gauge stabilizer (plastic tab) has been removed from the bottom of the sensor (see page 10). • Clear debris, such as leaves, out of the rain collector funnel and debris screen. • Calibrate the Rain Gauge (see page 25).
Inaccurate wind readings	<ul style="list-style-type: none"> • What is wind reading being compared to? Pro weather stations are typically mounted at 30 ft (9 m) high or more. Make sure to compare data using a sensor positioned at the same mounting height. • Check location of the sensor. Ensure it's mounted a minimum of 5 ft (1.5 m) in the air with no obstructions around it (within several feet). • Ensure wind cups are spinning freely. If they hesitate or stop try lubricating with graphite powder or spray lubricant.
Display screen not working	<ul style="list-style-type: none"> • Check that the power adapter is plugged into the display and an electrical outlet. • Reset the display by pressing and releasing the RESET button, located in the battery compartment of the display. Time and date will need to be entered after a reset.
Add-on Sensor not recognized	<p>If the display is being used with add-on Temperature & Humidity Sensors (models 06002 or 06044), the A-B-C channels must differ between each add-on sensor.</p> <ol style="list-style-type: none"> 1. Bring the display and wireless sensors together and position them side-by-side. 2. Unplug cord & remove the batteries from the display. 3. Verify that each sensor has a different A-B-C channel selected. <ul style="list-style-type: none"> • Model 06002 - Locate the A-B-C switch inside the battery compartment to adjust channel setting. • Model 06044 - Locate the A-B-C button on the back of the sensor to adjust channel setting (indicated on sensor display). 4. Re-install sensor batteries (if applicable). 5. Plug in & re-install display batteries. <p>NOTE: It may take a few minutes for the display and sensor(s) to synchronized after batteries are replaced.</p>
Interference Indicator is flashing	<ul style="list-style-type: none"> • Relocate the lightning sensor. • Make sure the lightning sensor is placed at least 3 feet (.9 m) away from electronics that may cause interference (see page 14).
<p>If your AcuRite product does not operate properly after trying the troubleshooting steps, visit www.AcuRite.com or call (877) 221-1252 for assistance.</p>	

Care & Maintenance

Display Care

Clean with a soft, damp cloth. Do not use caustic cleaners or abrasives. Keep away from dust, dirt and moisture. Clean ventilation ports regularly with a gentle puff of air.

5-in-1 Sensor Care

Clean the Sensor

Clean with a soft damp cloth. Do not use caustic cleaners or abrasives that will mar the polished surfaces of the rain collection funnel or the solar cell. Scratches will result in decreased performance and reliability.

Insect Prevention

Insects may cause obstructions and interrupt data by nesting in or on the 5-in-1 sensor. To limit this problem, spray sensor with a household insect repellent. Consult the insect repellent instructions prior to use.

Snow & Freezing Weather

The 5-in-1 sensor will not be damaged by freezing conditions. **NOTE:** If the rain collector cup fills with snow and then melts, it will register as rain on the display.

Clean the Rain Collector Cup

Remove and empty rain collector debris filter. The debris filter is located in the rain collector funnel. Remove from the top by gently squeezing and pulling out.

Clean the Wind Vane & Anemometer

Remove foreign matter from the outside of the sensor for free movement of the wind vane and anemometer. If needed, use a small amount of spray lubricant, clear silicone or graphite powder on the anemometer for improved movement.

Lightning Sensor Care

Clean with a soft, damp cloth. Do not use caustic cleaners or abrasives.

Calibration

The indoor and outdoor temperature and humidity readings, and barometric pressure* can be calibrated on the display to improve accuracy. Calibration can improve accuracy when sensor placement or environmental factors impact the data accuracy.

1. To access calibration mode, press and release the "select" button until the reading you wish to calibrate is shown on the Weather Ticker.
2. Press and release the "options" button.
3. If necessary, press and release the "∧" or "∨" button until "CALIBRATION" is shown on the Weather Ticker.
4. Press and release the "SET_{enter}" button. The currently selected item will flash on the display.
5. Press and release the "∧" or "∨" button to calibrate the data value higher or lower from the actual reading.
6. To save your adjustments, press and release the "SET_{enter}" button. The "☺" icon will remain illuminated next to calibrated values.
7. Repeat steps 1-6, as needed.

*Barometric pressure must be set to MANUAL mode to calibrate. To change from AUTO to MANUAL pressure mode and vice versa, press and release the "select" button until BAROMETER is shown on the Weather Ticker. Press and release the "options" button and then cycle through the options using the "∧" or "∨" button. Press and release the "SET_{enter}" button once the mode you desire appears on the Weather Ticker. The "محر" icon will appear next to the barometric pressure to indicate that MANUAL mode has been activated.

After 5-10 seconds of inactivity, the display will save the adjustments and exit calibration mode. **NOTE:** Calibrations will be erased if the display is reset or if batteries are removed and the power adapter is unplugged.

Calibrate the Rain Gauge

The rain gauge on the 5-in-1 sensor can be calibrated to improve accuracy.

Items Needed: 5-in-1 sensor, display, plastic cup, pin, screw driver

1. First, ensure 5-in-1 sensor is perfectly level using built-in bubble level.
2. Place display close so you can monitor it during calibration.
3. Make a pin hole in the bottom of a plastic cup. Hold the cup over the rain gauge and fill it with exactly 1 cup (8oz) of water, allowing the water to drip into the rain gauge. You should hear the internal buckets tip and see water drain through the rain gauge.
4. A few seconds after each bucket tip, the display displays rainfall in approximately 0.01" (.25 mm) or more increments.
5. The cup of water should take more than 20 minutes to empty; a quicker period will result in inaccurate calibration. Try to simulate a normal steady rainfall. When cup is empty of water, display should register 1.06" (27 mm).

Tips

- There should be nearly an equal number of water drops (about 25 water drops) between bucket tips. If not, adjust the calibration screws on the bottom of the 5-in-1 sensor until an equal number of water drops are tipping the buckets. Then, restart the calibration procedure.
- If you don't hear the buckets tipping and see water dripping alternately out of each drain, there may be an issue with the rain gauge or it's adjustment. See Troubleshooting on page 22.

Adjustment

If the rain gauge doesn't register close to 1.06" (27 mm), make an EQUAL adjustment to the two calibration screws on the bottom of the 5-in-1 sensor. Turning screws clockwise increases rainfall; counter clockwise decreases rainfall.

- To adjust the rainfall reading by 2% turn both screws 1/8 of a turn.
- To adjust the rainfall reading by 4% turn both screws 1/4 of a turn.
- To adjust the rainfall reading by 8% turn both screws 1/2 of a turn.

Watch the video at www.acurite.com/5in1

Specifications

TEMPERATURE RANGE	Outdoor: -40°F to 158°F; -40°C to 70°C
	Indoor: 32°F to 122°F; 0°C to 50°C
HUMIDITY RANGE	Outdoor: 1% to 99%
	Indoor: 1% to 99%
LIGHTNING DETECTION RANGE	1 - 25 miles / 1.6 - 40km
WIND SPEED	0 to 99 mph; 0 to 159 km/h
WIND DIRECTION INDICATORS	16 points
RAINFALL MEASUREMENT	0.01 inches (0.25 mm) and up
WIRELESS RANGE	330ft / 100m depending on home construction materials
OPERATING FREQUENCY	433 MHz
POWER	Display: 5V, 250mA adapter 6 x AA alkaline batteries (optional)
	5-in-1 Sensor: 4 x AA alkaline or lithium batteries
	Lightning Sensor: 4 x AA alkaline or lithium batteries
DATA REPORTING	Display: Indoor temperature & humidity: 60 second updates
	5-in-1 Sensor: Wind Speed: 18 second updates; Direction: 36 seconds; Outdoor temperature & humidity: 36 second updates
	Lightning Sensor: 24 second updates during normal conditions; 8 seconds once lightning detected

FCC Information

This device complies with part 15 of FCC rules. Operation is subject to the following two conditions:

- 1- This device may NOT cause harmful interference, and
- 2- This device must accept any interference received, including interference that may cause undesired operation.

WARNING: Changes or modifications to this unit not expressly approved by the party responsible for compliance could void the user's authority to operate the equipment.

NOTE: This equipment has been tested and found to comply with the limits for a Class B digital device, pursuant to Part 15 of the FCC rules. These limits are designed to provide reasonable protection against harmful interference in a residential installation. This equipment generates, uses and can radiate radio frequency energy and, if not installed and used in accordance with the instructions, may cause harmful interference to radio communications. However, there is no guarantee that interference will not occur in a particular installation. If this equipment does cause harmful interference to radio or television reception, which can be determined by turning the equipment off and on, the user is encouraged to try to correct the interference by one or more of the following measures:

- Reorient or relocate the receiving antenna.
- Increase the separation between the equipment and the receiver.
- Connect the equipment into an outlet on a circuit different from that to which the receiver is connected.
- Consult the dealer or an experienced radio/TV technician for help.

NOTE: The manufacturer is not responsible for any radio or TV interference caused by unauthorized modifications to this equipment. Such modifications could void the user authority to operate the equipment.

This device complies with Industry Canada licence-exempt RSS standard(s).

Operation is subject to the following two conditions:

- (1) This device may not cause interference, and
- (2) This device must accept any interference received, including interference that may cause undesired operation of the device.

Customer Support

AcuRite customer support is committed to providing you with best-in-class service. **For assistance**, please have the model number of this product available and contact us in any of the following ways:



(877) 221-1252

Visit us at www.AcuRite.com

- ▶ Installation Videos
- ▶ Register your Product
- ▶ Instruction Manuals
- ▶ Support User Forum
- ▶ Replacement Parts
- ▶ Submit Feedback & Ideas

IMPORTANT

PRODUCT MUST BE REGISTERED
TO RECEIVE WARRANTY SERVICE

PRODUCT REGISTRATION

Register online to receive 1 year warranty protection

www.AcuRite.com

Limited 1-Year Warranty

AcuRite is a wholly owned subsidiary of Chaney Instrument Company. For purchases of AcuRite products, AcuRite provides the benefits and services set forth herein. For purchases of Chaney products, Chaney provides the benefits and services set forth herein.

We warrant that all products we manufacture under this warranty are of good material and workmanship and, when properly installed and operated, will be free of defects for a period of one year from the date of purchase.

Any product which, under normal use and service, is proven to breach the warranty contained herein within ONE YEAR from date of sale will, upon examination by us, and at our sole option, be repaired or replaced by us. Transportation costs and charges for returned goods shall be paid for by the purchaser. We hereby disclaim all responsibility for such transportation costs and charges. This warranty will not be breached, and we will give no credit for products which have received normal wear and tear not affecting the functionality of the product, been damaged (including by acts of nature), tampered, abused, improperly installed, or repaired or altered by others than our authorized representatives.

Remedy for breach of this warranty is limited to repair or replacement of the defective item(s). If we determine that repair or replacement is not feasible, we may, at our option, refund the amount of the original purchase price.

THE ABOVE-DESCRIBED WARRANTY IS THE SOLE WARRANTY FOR THE PRODUCTS AND IS EXPRESSLY IN LIEU OF ALL OTHER WARRANTIES, EXPRESS OR IMPLIED. ALL OTHER WARRANTIES OTHER THAN THE EXPRESS WARRANTY SET FORTH HEREIN ARE HEREBY EXPRESSLY DISCLAIMED, INCLUDING WITHOUT LIMITATION THE IMPLIED WARRANTY OF MERCHANTABILITY AND THE IMPLIED WARRANTY OF FITNESS FOR A PARTICULAR PURPOSE.

We expressly disclaim all liability for special, consequential, or incidental damages, whether arising in tort or by contract from any breach of this warranty. Some states do not allow the exclusion or limitation of incidental or consequential damages, so the above limitation or exclusion may not apply to you.

We further disclaim liability from personal injury relating to our products to the extent permitted by law. By acceptance of any of our products, the purchaser assumes all liability for the consequences arising from their use or misuse. No person, firm or corporation is authorized to bind us to any other obligation or liability in connection with the sale of our products. Furthermore, no person, firm or corporation is authorized to modify or waive the terms of this warranty unless done in writing and signed by a duly authorized agent of ours.

In no case shall our liability for any claim relating to our products, your purchase or your use thereof, exceed the original purchase price paid for the product.

Applicability of Policy

This Return, Refund, and Warranty Policy applies only to purchases made in the United States and Canada. For purchases made in a country other than the United States or Canada, please consult the policies applicable to the country in which you made your purchase.

Additionally, this Policy applies only to the original purchaser of our products. We cannot and do not offer any return, refund, or warranty services if you buy products used or from resale sites such as eBay or Craigslist.

Governing Law

This Return, Refund, and Warranty Policy is governed by the laws of the United States and the State of Wisconsin. Any dispute relating to this Policy shall be brought exclusively in the federal or State courts having jurisdiction in Walworth County, Wisconsin; and purchaser consents to jurisdiction within the State of Wisconsin.

ACU RITE®



Weather
Stations



Temperature
& Humidity



Weather
Alert Radio



Kitchen
Thermometers
& Timers



Clocks

It's More than Accurate, it's ACU RITE.

AcuRite offers an extensive assortment of precision instruments, designed to provide you with information you can depend on to Plan your day with confidence™.

www.AcuRite.com